

MEDIZIN
& TECHNIK
MATERIAIS CIRÚRGICOS

Catalogo
2020

Sistema KM BABY

Your partner in spine surgery
NEURO FRANCE Implants

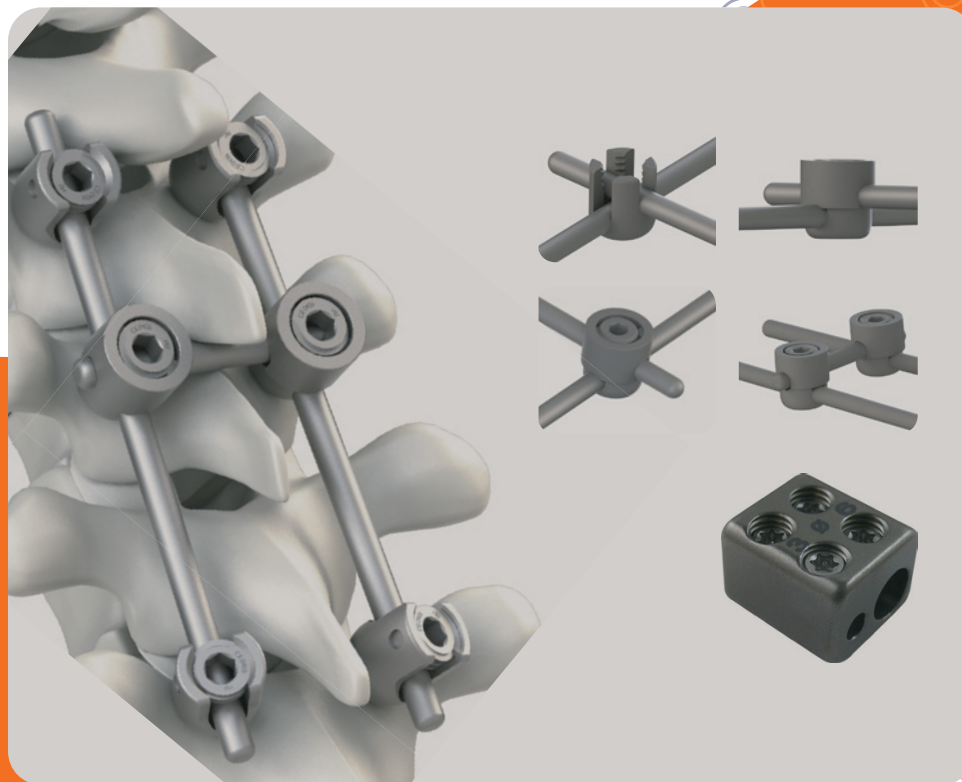

Coluna

- Adulto[massa lateral] e Pediátrico[toraco-lombar]
- Parafusos Monoaxiais e Poliaxiais de baixo perfil
 - Diâmetro: 3.5, 4 e 4.5mm
 - Comprimento: 10 a 30 mm
- Hastes: 3mm
 - Comprimentos: 50 mm a 400 mm
- Conector quadrado: Ø3/ Ø3, 5 e 6mm
- Cross Link:
 - Tamanhos: 20 - 70mm
 - Conector, barra, capacete e bloqueador

www.medizintech.com



**MEDIZIN
& TECHNIK**
MATERIAIS CIRÚRGICOS

Sistema JOC

Your partner in spine surgery
NEURO FRANCE Implants



Coluna

- Junção occipito cervical
- Barra Ø3mm, placa de Ø2,5mm
- Complementar ao sistema KM BABY
- Usado com parafusos cervicais STABILAR®
 - Diâmetro de 4mm
 - Comprimento 10, 12, 14, 16, 18, 20 e 22

www.medizintech.com



**MEDIZIN
& TECHNIK**
MATERIAIS CIRÚRGICOS

Sistema Occipitocervical (Via Posterior)



Coluna

Sistema para casos de fixação occipitocervical e ou cervical até primeiras vertebrae torácicas.

- Parafusos monoaxiais e poliaxiais
- Implantação rápida e segura
- Placas occipitocervicais de 3 ou 4 parafusos.
- Variedade de tamanhos para anatomia de cada paciente
- Maior segurança com o sistema de tração transversal com hastes, ganchos e bloqueadores

www.medizintech.com



**MEDIZIN
& TECHNIK**
MATERIAIS CIRÚRGICOS

Sistema para Massa Lateral

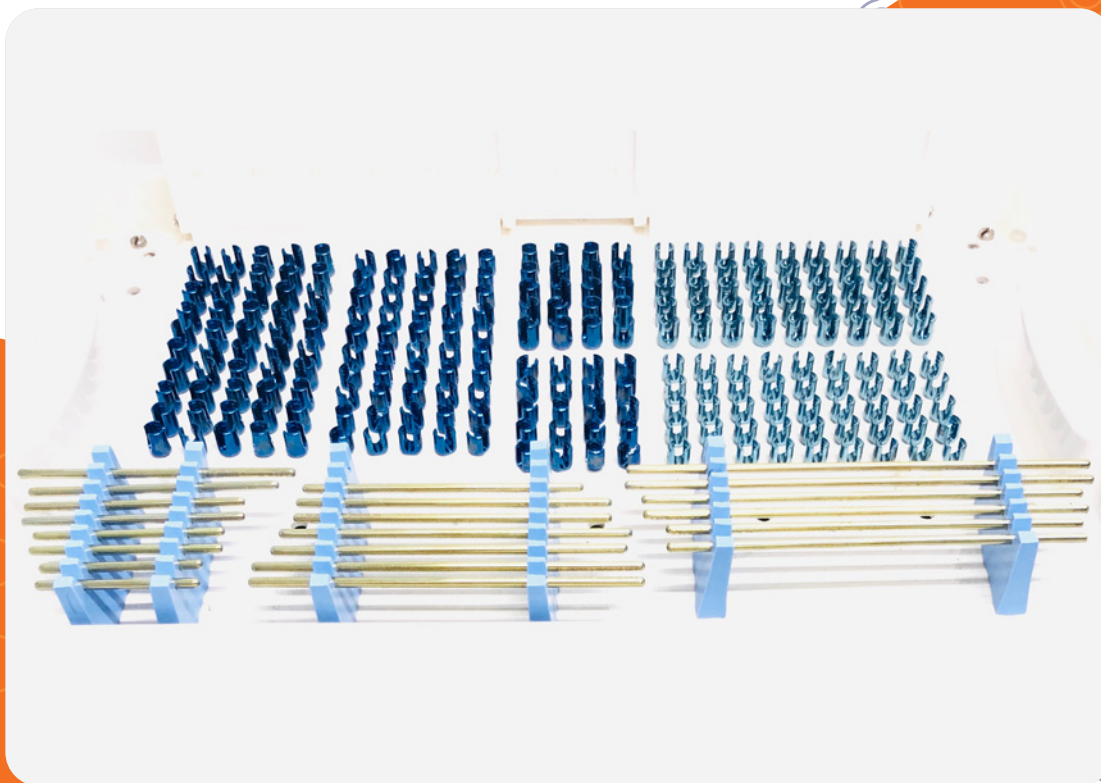

Coluna

- Parafusos Monoaxiais e Poliaxiais de baixo perfil
- Diâmetro: 3.65 e 4.15 mm
- Comprimento: 12 a 18 mm
- Hastes: 3.2 mm com comprimentos de 35 mm a 200 mm

www.medizintech.com



**MEDIZIN
& TECHNIK**
MATERIAIS CIRÚRGICOS

Dynalis - Protese Disco Cervical

Your partner in spine surgery
NEURO FRANCE Implants

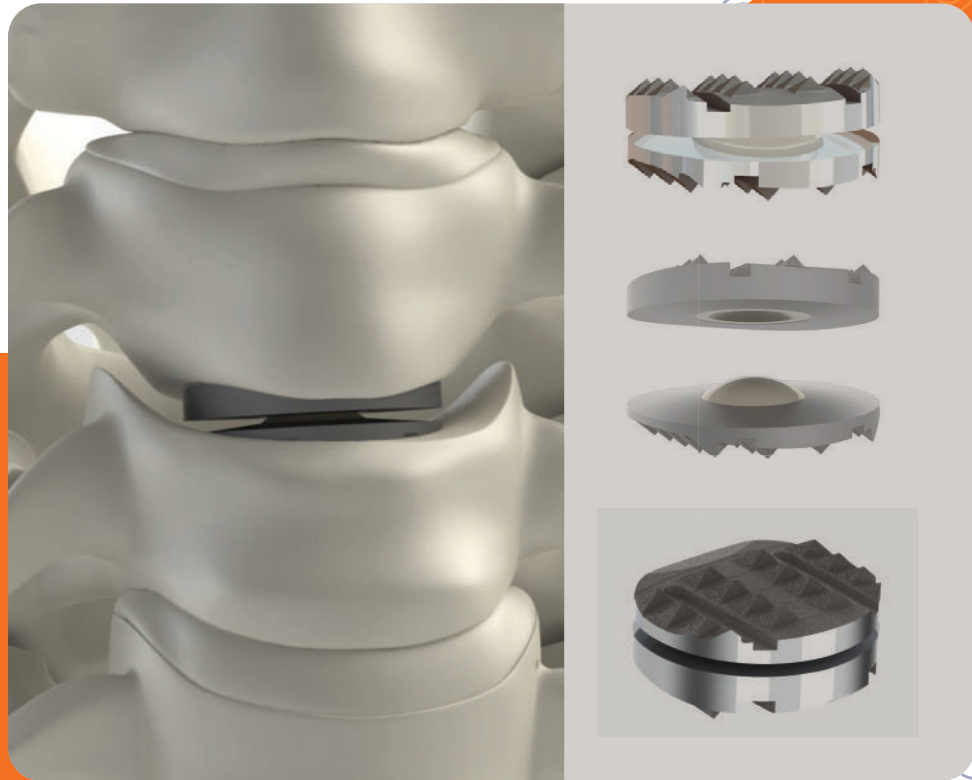

Coluna

- Mobilidade 3D sem restrição articular
- Liga de titânio Ti6-Al4-V
- Fixação primária pelas ranhuras anatômicas
- Fixação secundária através de revestimento de plasma de titânio
- Prótese anatômica
- Disco central em PEEK OPTIMA®
- Medidas: 13x15mm e 15x17mm
- Tamanhos: 5, 6, 7 e 8mm

www.medizintech.com



**MEDIZIN
& TECHNIK**
MATERIAIS CIRÚRGICOS

Cage Cervical Perfect-C

SeohanCare
Leader of Implant



Coluna

- Dupla ancoragem por parafuso
- Combinação de placa e parafuso eleva o nível de fixação e reduz o risco de subsidência.
- Design anatômico lordótico
- Ampla área para enxerto ósseo
- 3 marcadores radiopacos em titânio
- Tamanhos 5.5, 6.5, 7.5, 8.5mm X 14, 15mm X 13.5, 16mm
- Parafusos 3.5, 3.9mm X 14, 16 e 18mm

www.medizintech.com



**MEDIZIN
& TECHNIK**
MATERIAIS CIRÚRGICOS

Placa Cervical PM Butterfly

Your partner in spine surgery
NEURO FRANCE Implants

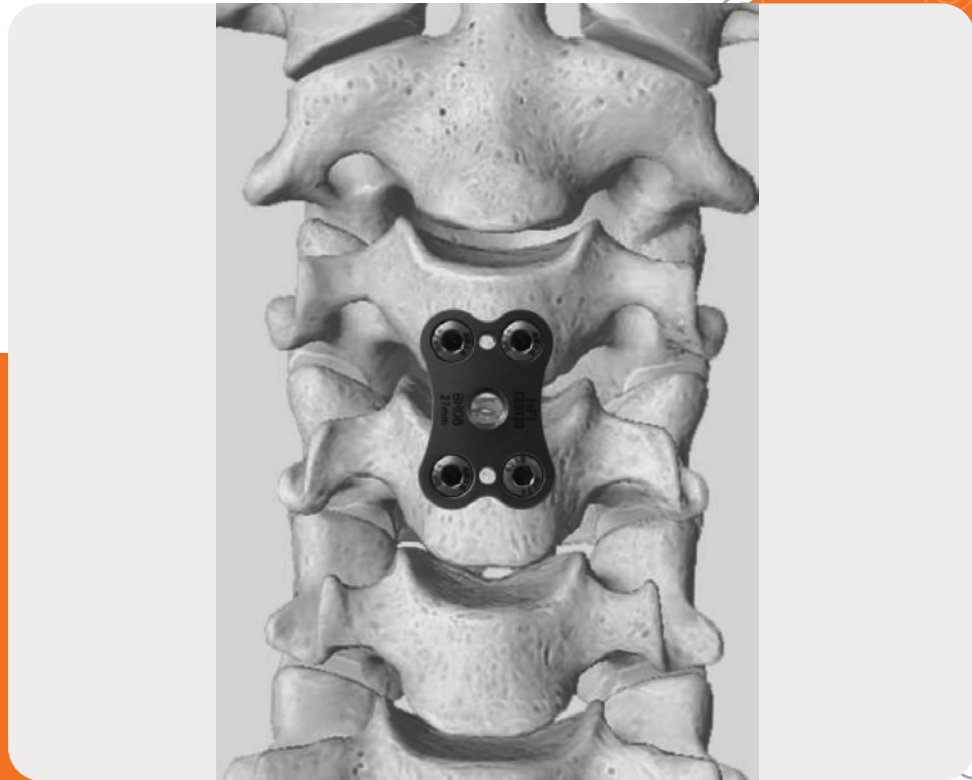

Coluna

- Abordagem cervical anterior
- Parafusos STABILAR sem bloqueio e com bloqueio (para osso osteoporótico)
- Ampla variedade de tamanhos
- Baixo perfil 1,80mm

www.medizintech.com



**MEDIZIN
& TECHNIK**
MATERIAIS CIRÚRGICOS

Cage Cervical PM

Your partner in spine surgery
NEURO FRANCE Implants



Coluna

- Design Anatômico
- Radiotransparente
- Com marcadores radiopacos
- 4 graus de lordose
- Grande superfície de enxerto
- Tamanhos: 4.0 a 11.0mm
- Em PEEK

www.medizintech.com



**MEDIZIN
& TECHNIK**
MATERIAIS CIRÚRGICOS

Placa Cervical Anterior



Coluna

- Placas de 22 a 110 mm
- Baixo perfil 2.0 mm
- Parafuso 3.85 mm
- Parafuso de emergência 4.25 mm

www.medizintech.com



**MEDIZIN
& TECHNIK**
MATERIAIS CIRÚRGICOS

Cage Dicom Cervical



Coluna

- Cage Cervical com pinos em titânio para ancoragem
- Tamanhos: 5.0 a 8.0mm
- Radiotransparente
- Em PEEK

www.medizintech.com



**MEDIZIN
& TECHNIK**
MATERIAIS CIRÚRGICOS

Cage Fusimax Autobloqueante



Coluna

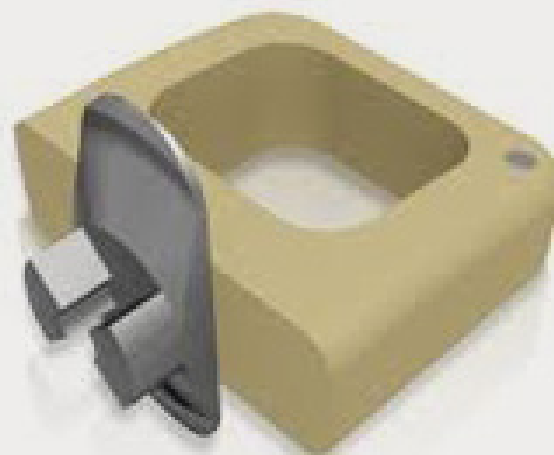

- Cage cervical com trava acoplada
- Dispensa placas e parafusos
- Radiotransparente
- Em PEEK

www.medizintech.com



**MEDIZIN
& TECHNIK**
MATERIAIS CIRÚRGICOS

Cage Gaiola Cervical



Coluna

- Diâmetros: 9, 12 e 14 mm
- Comprimentos: 9 a 30 mm
- Extremidades serrilhadas
- Cavidade para enxerto

www.medizintech.com



**MEDIZIN
& TECHNIK**
MATERIAIS CIRÚRGICOS

Cage Banane (TLIF)

 SeohanCare
Leader of Implant



Coluna

- Design anatômico (ponta bala)
- Superfície serrilhada, minimiza risco de migração
- Em PEEK, com 3 marcadores radiográficos em titânio
- Tamanhos: 7, 8, 9, 10, 11, 12, 13 e 15 mm

www.medizintech.com



**MEDIZIN
& TECHNIK**
MATERIAIS CIRÚRGICOS

Cage Dimei Lombar (TLIF)



Coluna

- Inserção bilateral
- Medidas de 7 a 12 mm;
- Radiotransparente com Marcadores Radiológicos
- Em PEEK

www.medizintech.com



**MEDIZIN
& TECHNIK**
MATERIAIS CIRÚRGICOS

Cage Dimei Lombar (PLIF)



Coluna

- Inserção bilateral
- Medidas de 7 a 12 mm;
- Cage Lordótico que preserva a curvatura lombar
- Radiotransparente com Marcadores Radiológicos
- Em PEEK

www.medizintech.com



**MEDIZIN
& TECHNIK**
MATERIAIS CIRÚRGICOS

Cage Gaiola Toracolombar



Coluna

- Diâmetros: 16, 19 e 25 mm
- Comprimentos: 20 a 130 mm
- Extremidades serrilhadas
- Cavidade para enxerto

www.medizintech.com



**MEDIZIN
& TECHNIK**
MATERIAIS CIRÚRGICOS

Sistema KM

Your partner in spine surgery
NEURO FRANCE Implants



Coluna

- Parafusos com cabeça de baixo perfil
- Automacheantes
- Cabeça para redução de listese
- Escoliose
- Tamanhos: 4.5, 5.5, 6.5 e 7.5
- Conector cilíndrico Ø5/6mm, Ø6/6mm
- Conector quadrado: Ø3/5 e 6mm e Ø5/6mm e Ø6/6mm

www.medizintech.com



**MEDIZIN
& TECHNIK**
MATERIAIS CIRÚRGICOS

Cross Link KM

Your partner in spine surgery
NEURO FRANCE Implants

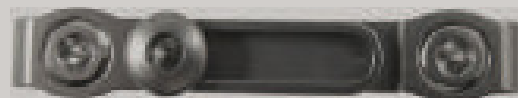

Coluna

Peça única articulável

• Tamanhos:

- 29 a 35 mm

- 34 a 45 mm

- 44 a 65 mm

- 64 a 105 mm

www.medizintech.com



**MEDIZIN
& TECHNIK**
MATERIAIS CIRÚRGICOS

Hastes KM

Your partner in spine surgery
NEURO FRANCE Implants



Coluna

- Hastes em titânio com extremidade hexagonal
 - Hastes de 6mm
- Tamanhos: 45 a 480 mm

www.medizintech.com



**MEDIZIN
& TECHNIK**
MATERIAIS CIRÚRGICOS

Sistema Megafix

SeohanCare
Leader of Implant

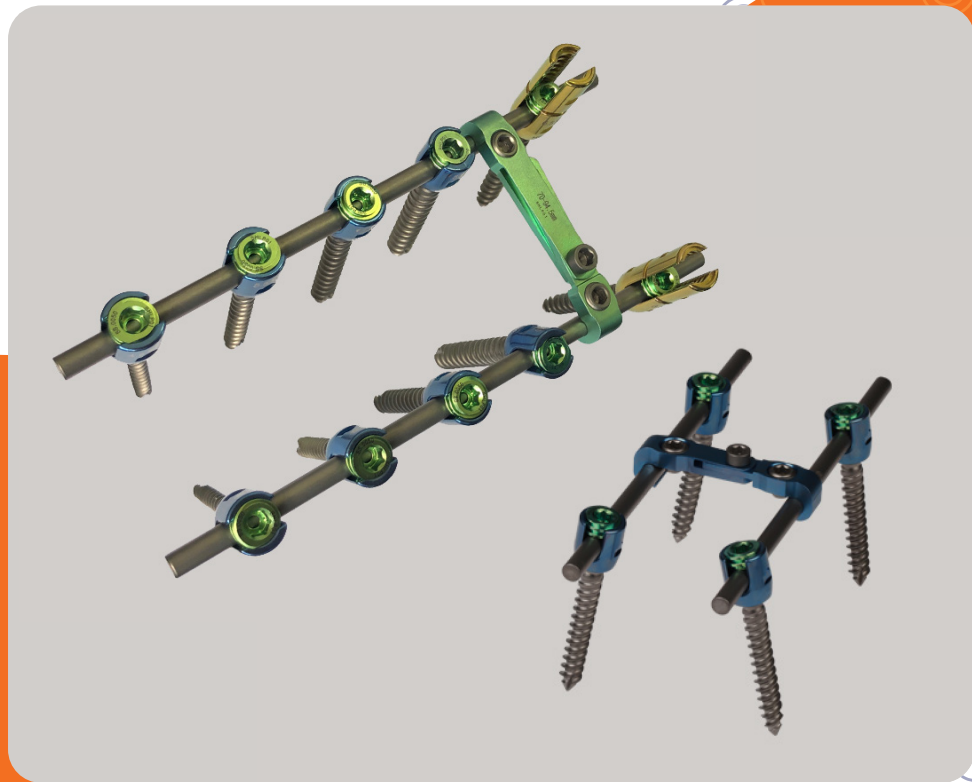

Coluna

- Parafusos Pediculares: Monoaxial, Poliaxial, Espodilolistese e Canulado
- Em Titânio, automacheantes e rosca dupla
- Parafuso de trava com rosca única

www.medizintech.com



**MEDIZIN
& TECHNIK**
MATERIAIS CIRÚRGICOS

Cross Link Megafix

SeohanCare
Leader of Implant



Coluna

- Peça única articulável
- Tamanhos:
 - 52 a 58 mm
 - 58.5 a 71 mm
 - 70 a 94.5 mm

www.medizintech.com



**MEDIZIN
& TECHNIK**
MATERIAIS CIRÚRGICOS

Haste Pré-moldada Megafix

SeohanCare
Leader of Implant

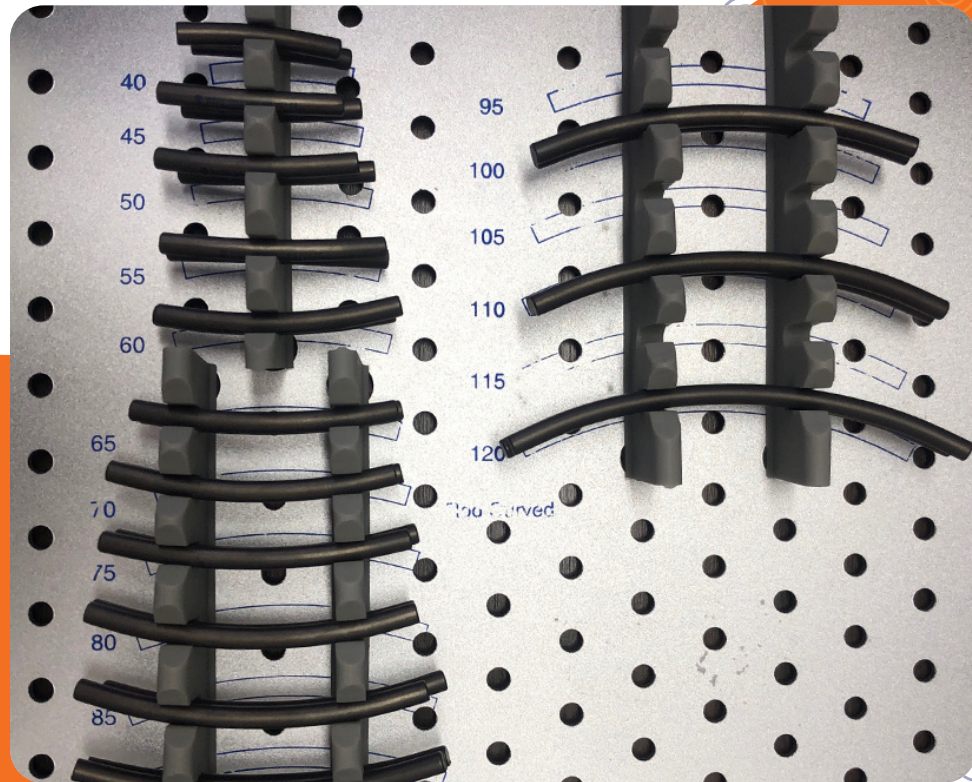

Coluna

- Hastes em titânio, pré-moldadas
- Tamanhos: 40 a 120 mm

www.medizintech.com



**MEDIZIN
& TECHNIK**
MATERIAIS CIRÚRGICOS

DPZ Lombar



Coluna

- Parafuso poliaxial tóraco-lombar
- Baixo perfil
- Diâmetro: 4.5, 5.0, 6.0 e 7.0 mm
- Comprimento: 35 a 50 mm
- Hastes de 35 a 200 mm

www.medizintech.com



**MEDIZIN
& TECHNIK**
MATERIAIS CIRÚRGICOS

Cross Link DTT

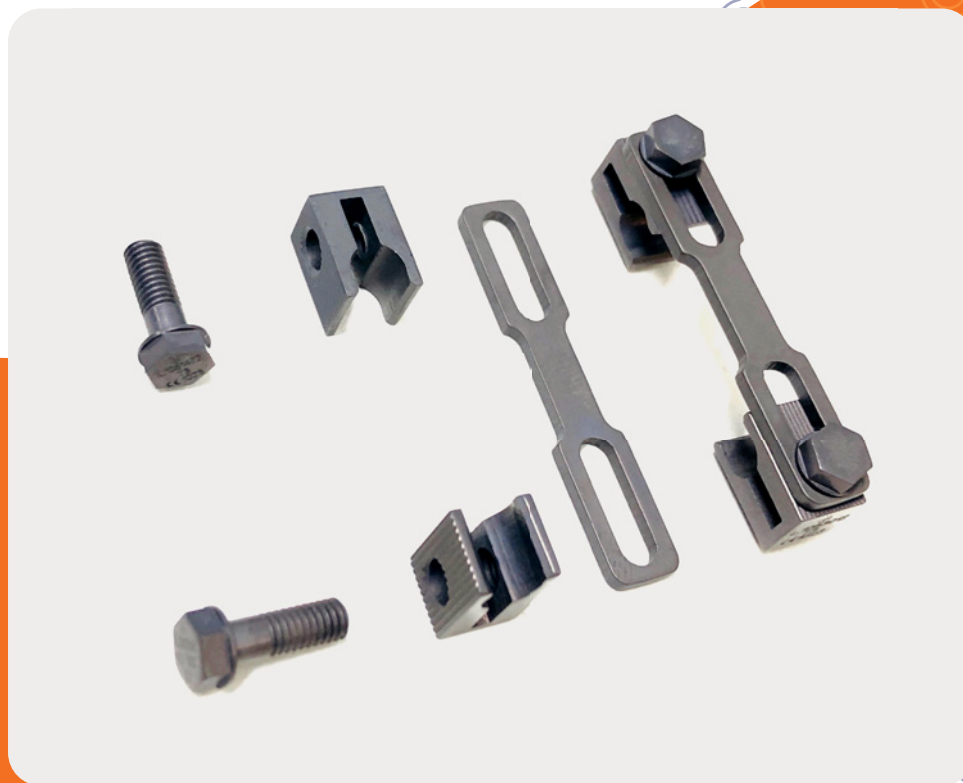

Coluna

- Composto de 2 ganchos, 2 parafusos e 1 barra
- Barras de 35 a 75 mm

www.medizintech.com



**MEDIZIN
& TECHNIK**
MATERIAIS CIRÚRGICOS

Kit Biópsia



Coluna

Indicado para obtenção de material para biópsia em pacientes com tumor ou infecção vertebral.

- Dupla embalagem estéril
- Uso único

www.medizintech.com



**MEDIZIN
& TECHNIK**
MATERIAIS CIRÚRGICOS

Kit para Vertebroplastia



Coluna

- kit estéril para uso único.
- Instrumentais para perfuração
- Recipiente para preparação do cimento
- Seringa e aplicador de cimento ósseo

www.medizintech.com



**MEDIZIN
& TECHNIK**
MATERIAIS CIRÚRGICOS

Cifoplastia Aluminium



Coluna



- Sistema expansor de osso para tratamento de fratura de corpo vertebral
- Insuflador digital: Merit Medical
- Balões cirúrgicos: Edwards

www.medizintech.com

Endoscopia de Coluna



Coluna

- Tamanho 16, 18, 20 e 22cm
- Ponta Ativa 1.5 mm

www.medizintech.com



**MEDIZIN
& TECHNIK**
MATERIAIS CIRÚRGICOS

Bomba de irrigação

CONMED



Coluna

- Display intuitivo
- Configuração rápida
- Resposta imediata
- Auto fluxo
- Pressão máxima de 150mmhg
- Fluxo máximo de 2000ml/min

www.medizintech.com



**MEDIZIN
& TECHNIK**
MATERIAIS CIRÚRGICOS

Shaver Osteomax



Coluna

- Indicado para cortes, perfurações e desbastes ósseos.
- Micromotor elétrico velocidade modo direto e reverso
 - 2.000 a 45.000rpm
- Peça de mão de shaver
 - Velocidade modo oscilante 500 a 3.000 rpm
 - Velocidade modo direto e reverso 500 a 8.000 rpm
- Pedal triplo

www.medizintech.com



**MEDIZIN
& TECHNIK**
MATERIAIS CIRÚRGICOS

Kit Cânula Para Debridaç o  ssea



Coluna



Broca Oval - **OBC**
(2,4 mm)



Broca Afilada com
Prote o - **TBPC**
(2,4 mm)



Broca
Afilada - **TBC**
(2,4 mm)



Broca
Diamantada - **DBC**
(2,4 mm)



Broca
Redonda - **RBC**
(2,4 mm)

Utilizado em procedimentos cir rgicos percut neos de coluna

- Em balagem est ril
- Produto de uso  nico

www.medizintech.com



**MEDIZIN
& TECHNIK**
MATERIAIS CIR RGICOS

Kit Cãnula de Discectomia Percutânea de disco

 Razek®

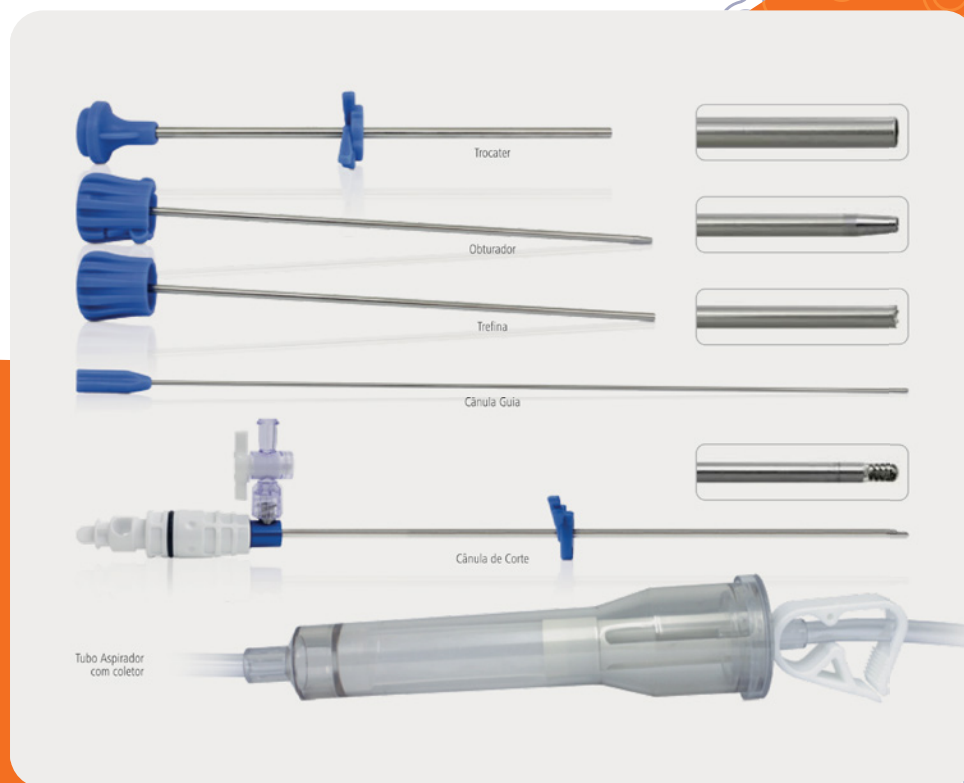

Coluna

Em conjunto com aparelho de shaver, fornece um método minimamente invasivo para descompressão da hérnia de disco vertebral.

- Embalagem estéril
- Produto de uso único

www.medizintech.com



**MEDIZIN
& TECHNIK**
MATERIAIS CIRÚRGICOS

Kit Cãnula de Acesso e Raspagem Óssea RZ

 Razek®

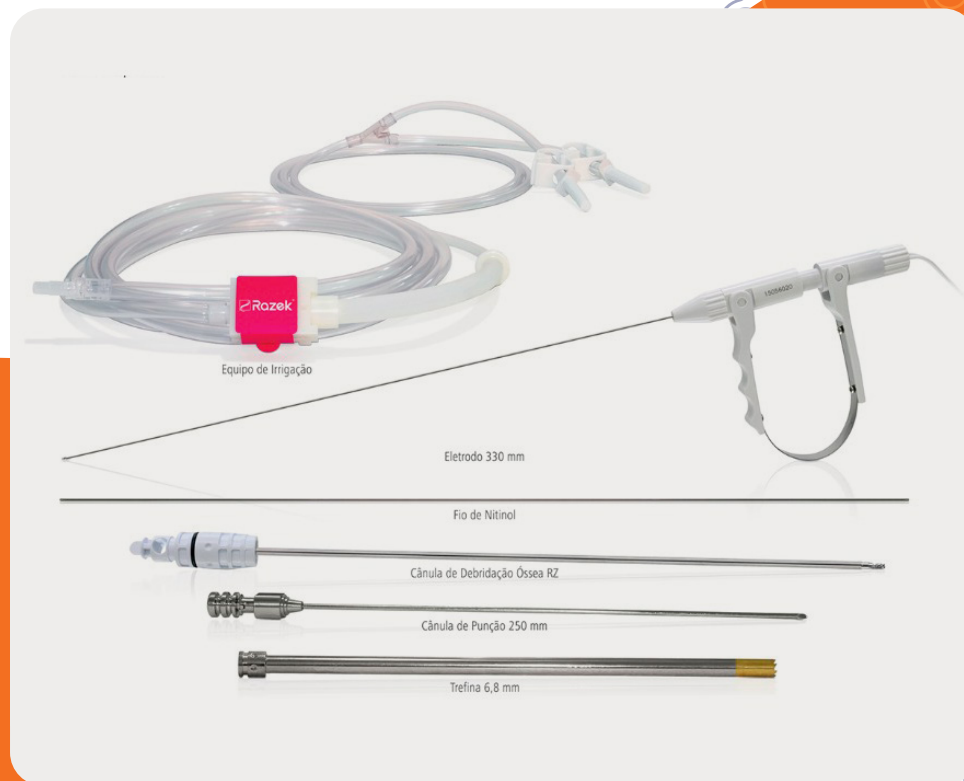

Coluna

Instrumento descartável para procedimentos cirúrgicos percutâneos de coluna.

- Embalagem estéril
- Produto de uso único

www.medizintech.com



**MEDIZIN
& TECHNIK**
MATERIAIS CIRÚRGICOS

Surg Fórceps



Coluna

Eletrodo Surg Forceps é utilizado em cirurgias, minimamente invasiva, para discectomia percutânea de disco, associada a técnicas cirúrgicas que realizam a ablação e descompressão do núcleo discal cervical e lombar.

www.medizintech.com



**MEDIZIN
& TECHNIK**
MATERIAIS CIRÚRGICOS

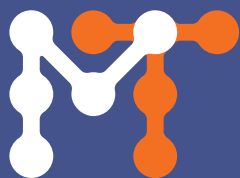

MEDIZIN
& TECHNIK
MATERIAIS CIRÚRGICOS

www.medizintech.com